

The Product Safety Engineering Newsletter

Vol. 4, No. 2 June 2008

What's Inside

President's Message.....	1
Officers of the IEEE PSES.....	2
Chapter Safety Probes.....	4
Touch Current Measurement Comparison.....	6
Electric Strength Test: What Voltage Should be Used?	19
News and Notes.....	16
Editorial.....	18

President's Message

Five years already? We are now on our fifth year of being an IEEE Society. There have been many unplanned hurdles over the last five years; some almost put us out of business. We have managed to deal with all of the issues, some more successfully than others. We still have two important hurdles to get over. IEEE Societies are run like any business would be run and like any other business surviving five years is a tough thing to do. We have reached a point where we are financially OK, and will continue to survive for the near term. We would not have been able to do so with out those who have given us grants to stay afloat. We would like to have a Distinguished Speaker program, but currently do not have the finances to do so.

The two hurdles we still have to get over both will occur in February 2009. As members of the society you can help us get over them. Getting over them will be determined by events this year. First one is we are currently listed as a "Provisional Society" and have to go through yearly society reviews, where normal societies go through the

review once every three years. As a provisional society we either resolve the issues or be merged with another society. The other is we are on TAB Fincom's (Technical Activities Board Financial Committee) watch list. As we started five years ago with just a grant from one of the safety agencies, we did not have the required reserves to start with, which put us on the list. Due to the success of our symposiums and a few grants, we have reached a point where we have the required reserves. We need to continue to watch our reserves to make sure we keep them in line with our activities.

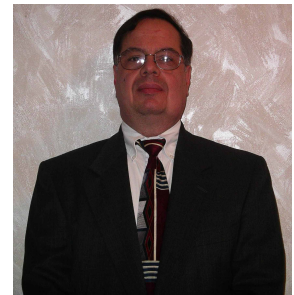

How can your help? 1. We need to continue to improve our membership numbers. To help, please promote membership. 2. We need to improve our paper flow for the newsletter, etc. Please consider writing papers or doing a workshop. 3. Help start

**The
Product
Safety
Engineering
Newsletter**

The Product Safety Engineering Newsletter is published by the IEEE Product Safety Engineering Society. No part of this newsletter may be reproduced without written permission of the authors. All rights to the article remain with the authors.

Opinions expressed in this newsletter are those of the authors and do not necessarily represent the opinions of the Society or any of its members. Indeed, there may be and often are substantial disagreements with some of the opinions expressed by the authors.

Copyright 2008 IEEE Product Safety Engineering Society.

Newsletter Committee

Editor:

Gary Weidner 1-563-557-0717 (v) 1-563.557.0725 (fax) gweidner@ieee.org

Co-Editors:

Michael S. Morse Ph. D. mmorse@sandiego.edu
 Richard Nute richn@ieee.org
 Nosh Medora nmedora@exponent.com
 Lal Bahra Lal_Bahra@Dell.com
 Lingfeng Chen gzclf2-ieee@yahoo.com.cn

News & Notes:

Your name here

Chapter Activities:

Stefan Mozar s.mozar@ieee.org

Page Layout:

Jim Bacher 1-937.865-2020(v) 1-937.865.2048 (fax) j.bacher@ieee.org

IEEE PSES Officers

Executive Committee	Name	Term
President	Jim Bacher	(08-09)
Past President	Henry Benitez	(08-09)
President Elect	TBD	
Secretary	Daniece Carpenter	(07-08)
Treasurer	Murlin Marks	(07-08)
Vice President - Communications	Dan Roman	(07-08)
Vice President - Member Services	Ken Thomas	(07-08)
Vice President - Technical Activities	Jack Burns	(07-08)
Vice President - Conferences	Richard Georgerian	(07-08)

Directors At Large

Term Expires 12/08	Term Expires 12/09	Term Expires 12/10	Ex Officio (without vote)
Jack Burns	Daniece Carpenter	Jim Bacher	Chapter Chairs
Murlin Marks	Richard Georgerian	Mark Montrose	Standing Committee Chairs
Richard Pescatore	Elya Joffe	Doug Nix	IEEE HQ
Ken Thomas	Daniel Nachtigall	Peter Tarver	IEEE TAB Division VI Director
			Gold Member

IEEE PSES Web Sites

- <http://www.ieee-pses.org/>
- <http://www.ieee-pses.org/symposium/>
- <http://www.ieee-communities.org/emc-pstc>
- <http://www.ieee-pses.org/emc-pstc.html>
- <http://www.ieee-pses.org/newsletters.html>
- <http://www.ieee-pses.org/pses.html>



a PSES chapter in your area. 4. We need to improve the attendance at the symposiums, so promote the symposium and be at the symposium. Basically we need to keep growing in all areas, which is going to be tough to do in today's climate. However, if everyone helps promote, etc. we can keep the society going and growing.

As this is our fifth year we will be having our fifth symposium. The committee is hard at work working out all the details and special events. One major change this year will be that it has been extended to two-and-a-half days. This is due to the quantity and quality of the papers being submitted. The symposium as in the past will cover the wide range of product compliance topics. Abstracts of presentations are now available on the symposium website at:

www.ieee-pses.org/symposium/index.html

For the first time we will have two Co-Keynote Speakers, June Anderson—IBM and Dave Adams—HP (BIOs on page 3). They will be giving industry perspective on certification and safety issues, from very experienced compliance professionals employed by key industry players. This is a chance to share real-life practical experiences.

Not to mention a chance to visit beautiful Austin, Texas in October—the live music capital of the world and home to the University of Texas. www.austintexas.org
Expect some really cool things at this years symposium. Online registration is now open.

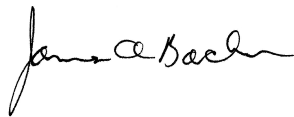

James A. Bacher
President IEEE PSES

Bio Summary for June Andersen

June Andersen joined IBM in 1974 and is a Distinguished Engineer who manages IBM's global corporate staff with responsibility for product safety and hardware compliance. Hardware compliance includes the areas of product safety, electromagnetic compatibility, regulatory standards, and IBM's Laboratory for telecommunications certification in La Gaude, France. She is an active member of IBM's Academy of Technology and past member of the Technology Council.



She holds a B.S. in Physics from the University of Missouri and a Ph.D. Degree in Genetics from Stanford University and is married with two sons.

June Andersen, PhD
Corporate Manager, Product Safety and Hardware Compliance

Chapter Safety Probes

To see current chapter information please go to the
chapter page at:

<http://www.ieee-pses.org/Chapters/index.html>

People Looking To Start Chapters

Denver Colorado

Richard Georgerian

voice: (303) 833-2327

e-mail: richardg@ieee.org

Toronto Ontario

Doug Nix

dnix@ieee.org

voice: (519) 729-5704

FaX: (519) 653-1318

North Carolina

Warren Fields (ncps@bellsouth.net).

Dallas Texas

Mike Cantwell, PE

Sr. Account Representative

Intertek ETL SEMKO

420 N. Dorothy Dr.

Richardson, TX 75081

Tel: 972-238-5591 x107

Fax: 972-238-1860

e-mail: mike.cantwell@intertek.com

or

Bill Paschetag b.paschetag@verizon.net

Southern California

Charles Bayhi (bayhi@cpsm-corp.com).

New PSES Members from 31 March 2008 Through 30 June 2008

Abdullah S Al-Jehani
Ademola Henry Oladeinde
Ahmad Ferouz
Andre R Fortin
Arnold Offner
Bansidhar Jagannath Phansalkar
Benjamin King
Brad Sybouts
Brian R Smith
Chris Sutton
Daniel Bejnarowicz
David A Baron
Donald Zeck
Fred Buton
Fred Porter
Glyn R Garside
Govinda Rao V Rao
Gregory Dale
Hun Yi Lock
Hyo Jin Lee
Ian McDonald
Ismael B Agasino
James W Christgau
Jiri Prinosil
John M Hawley
Jon Kalfus
Joseph M Jungblut
Joyce Choi
Judith A OConnor
Kerwinn Corpuz
Lingfeng Chen
Martin Fedor
Mathew B aschenberg
Mitsunori Hase
Nadrae Tayian Waugh
Nandhinidevi S S
Peter M Hart
Radha Krishna Darbha
Raghavendra Choudary Chitturi
Raymond C Denchfield
Ron Garcia
Saeed Ahmad
Sanjeev K Saini

Selman Demirel
Suren V Soman
Tony Toth
Vincent Sylvester
Wayne Charest
Zhen N Low

Our new members are located in the following countries: Australia, Canada, China, Czech Republic, India, Jamaica, Korea (South), Nigeria, Saudi Arabia, Singapore, Turkey, USA

Touch Current Measurement Comparison

Touch Current Measurement Comparison: Looking at IEC 60990 Measurement Circuit Performance

Part 1: Electric Burn

by Peter E. Perkins, PE

Abstract

This article examines in some detail the performance of IEC 60990 circuits, considering specific conditions or waveforms. Conditions of electric burn (eBurn) plus electric shock (via touch current, TC) response by these circuits are shown. Examples are provided to show a range of waveforms and their calculated response.

The discussion is divided into two parts: Part 1, Electric Burn (eBurn), then Part 2, Electric Shock comparisons across two circuits—startle-reaction circuit and let-go circuit. These results are compared to a TC waveform to show a relation to modern electronic equipment.

This article confirms the continued need for peak measurements for TC waveforms from electronic equipment.

Introduction

The requirements for Electric Burn and Electric Shock protection are given in product safety standards—in several different ways and formats. The fundamental requirements for these come from IEC 60479 series (Effects of electric current on the human body) and are developed as measurement methods in IEC 60990 (measurement of touch current and protective conductor current). Both of these standards are Basic Safety Publications within the IEC and therefore apply to all product standards. This article brings together these basic requirements and shows how they are analyzed using the measurement methods of IEC 60990 (which are the same as used in many product standards). This is a tutorial to help the working product safety professional understand the fundamental requirements and how to properly ascertain how they apply to product evaluation.

PART 1: ELECTRIC BURN

Product safety standards:

- Commonly give limits for electric burn from HF sources.
- HF applies somewhere above 30 kHz (as commonly believed).
- Measurement specifies the use of unweighted (IEC 60990, Fig. 3) circuits.
- Sinusoidal waveforms are assumed.
- RMS measurements are specified.

The purpose of an eBurn specification is to limit the burn to a person touching such a circuit. Earlier workers had been concerned with contact with HF circuits—wires, screw heads or connectors—which would primarily be finger contacts. Contact with wires—either end-on (wire diameter) or along the wire (very narrow width by 3–10 mm long)—involves a very small skin area. Larger finger contacts in the range of 3–10 mm across seem to be the right order of magnitude. For a circle or a square contact this area is in the range of 7–100 mm²; more generally this is on the order of tens of mm².

A small black burn spot from a quick contact with a small wire diameter is very acceptable; a narrow line burn seems similarly acceptable. Larger burns, e.g. from a screw connector or the like, are more of a problem. Even larger area contact and burn can be available on a circuit board. A dinner plate-sized reddened area eBurn doesn't seem acceptable. Large carbonized areas of skin are not acceptable.

IEC 60065	70 mA pk > 100 kHz
IEC 61010	70 mA (normal limit) rms
IEC 61010	500 mA rms (fault limit)
IEC 60950	70 mA rms
prIEC 62368	50 mA @ 100 kHz (ES1) rms
prIEC 62368	100 mA @ 100 kHz (ES2) rms

Table 1. Some product standard electric burn limits.

From the product standard limits shown in Table 1, it can be seen that IEC 60065 specifies 70 mA pk ac using the unweighted TC measuring network. This applies to frequencies above 100 kHz.

IEC 61010 specifies 70 mA rms normal limit and 500 mA rms fault limit which relates to possible burns at higher frequency.

IEC 60950 specifies for Limited Current Circuit (LCC): 0.7 mA pk < 1 kHz; $0.7 \times f$ in kHz (= 70 mA at 100 kHz) (cl 2.4.2).

The new, proposed prIEC 62368 specifies ac (1 kHz–100 kHz) current: ES1 limit $d \cdot 0.5$ mA rms \times f in kHz (= 50 mA at 100 kHz) and ES2 limit $d \cdot 5$ mA rms + $0.95 \times f$ in kHz (= 100 mA at 100 kHz)¹.

The unweighted measurement circuit shown in Figure 1a is also a basic part of each weighted measurement circuit found in IEC 60990. This fundamental body model circuit has been used for the last 50 years or so in electric shock evaluations. In this SPICE circuit representation the input conditions

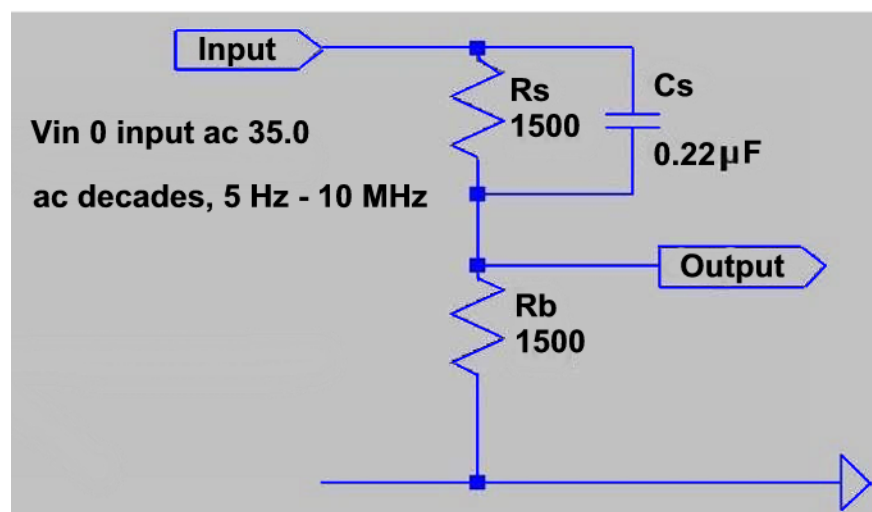

Figure 1a.

¹ ES1 and ES2 are the new electric shock source descriptions used in the hazard based standard prIEC 62368. They are different than has been used before as they include both current and voltage limits in the definition of acceptable levels.

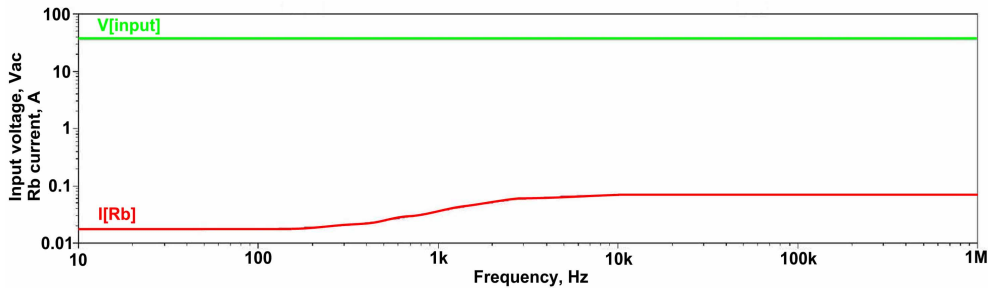

Figure 1b

Figure 1. Unweighted measurement circuit from Figure 3 of IEC 60990, (a) and current (b).

are specified and define the voltage input to the circuit as well as the frequency over which the evaluation is to be done; this is true of all the SPICE circuits shown here and the data captures the specific analysis done for that case.

Figure 1b shows the increase in current with frequency due to the bypass capacitor in the model. This increase is about a factor of 4 from LF to HF and the transition occurs in the region of about 0.5 kHz–5 kHz or so.

Standard	LF current	HF current
IEC 60065	12.5 mA rms	50 mA rms
IEC60950	17.5 mA rms	70 mA rms
IEC 61010	17.5 mA rms (normal limit)	70 mA rms
IEC 61010	126 mA rms (fault limit)	500 mA rms
prIEC 62368	12.5 mA rms	50 mA rms
prIEC 62368	25 mA rms	100 mA rms

Table 2. Summary of calculated eBurn data.

The response curve in Figure 1b shows 70 mA rms HF current which corresponds to some of the values used in the standards shown in Table 1. The shape of the curve is the same for any sinusoidal input signal; the LF and HF current values change as the input changes.

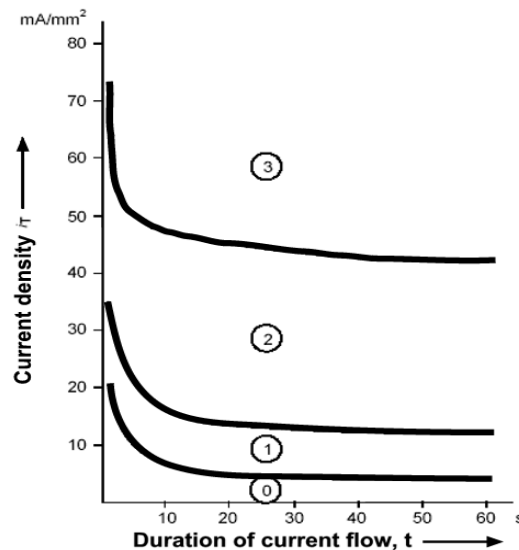

Figure 2. Skin eBurn effects (IEC 60479-1, Figure 14). Zone 3 = carbonization of skin; Zone 2 = current marks; Zone 1 = reddening of skin; Zone 0 = no effects.

Table 2 summarizes the calculated results of a SPICE analysis for the several eBurn limits given in the standards discussed. Note that IEC 60065 specifies a peak limit but, since eBurn only applies to sinusoidal waveforms, this has been converted to rms values for this analysis. The low frequency values are noted as they provide a basis for starting the discussion, which is frequency dependant, as was shown.

From Figure 2 the following can be seen:

- Reddening of the skin occurs at about 20 mA/mm² in a second or so—the shortest time a person can pull away by reaction. A finger contact area of 100 mm² results in a current of 2000 mA (2 A), a large current to which to subject a person.
 - Current marks occur at about 35 mA/mm². A finger contact area of 100 mm² results in a current of 3500 mA (3.5 A).
 - Carbonization of the skin occurs at about 75 mA/mm². A finger contact area of 100 mm² results in a current of 7500 mA (7.5 A). Longer term effects, tens of seconds, are lower.
- The data from IEC 60479-1 does not show frequency dependence for eBurn.

Area, mm ²	Current in mA		
	20 mA/mm ²	35 mA/mm ²	75 mA/mm ²
7	140	245	575
10	200	350	750
20	400	700	1500
50	1000	1750	3750
100	2000	3500	7500

Table 3. eBurn currents for various areas and current densities.

In Table 3 the short time maximum current density values from Figure 2 are combined with expected contact areas to yield values of current. Note that the highest value considered here is 7.5 A over a 10 cm by 10 cm area. The LF currents calculated ranged from 12.5 mA to 126 mA.

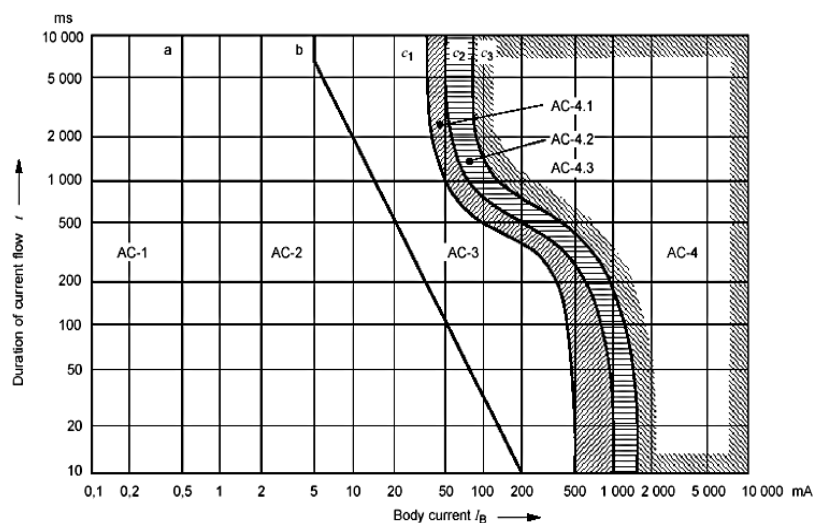

Figure 3. LF ac duration vs. body current (IEC 60479-1, Figure 20). The reader is referred to IEC 60479 for details of graph nomenclature not discussed in this article.

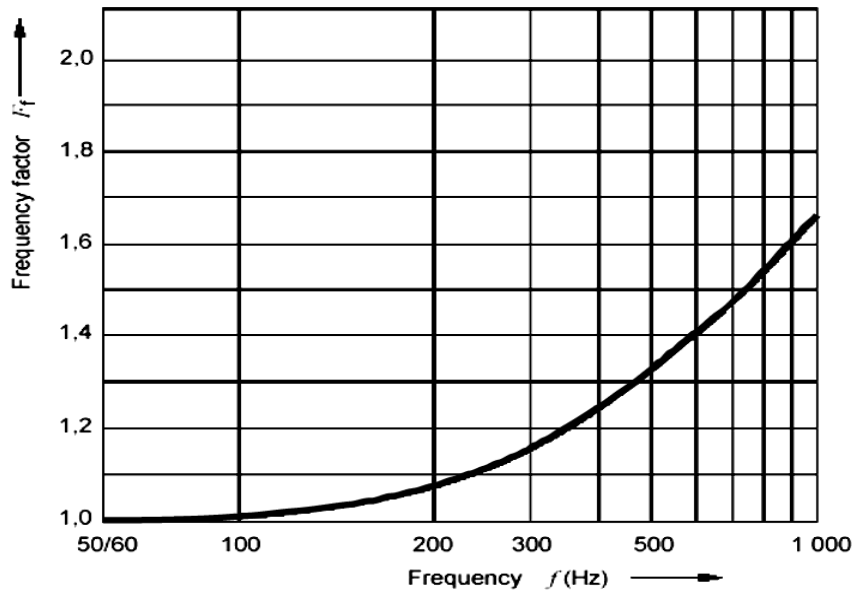

Figure 4. Frequency factor for ventricular fibrillation, for waveforms > one heart cycle and longitudinal through the body (IEC 60479-2, Figure 3).

Figure 3(from IEC 60479-1) shows that a one second contact at 50 mA will produce ventricular fibrillation (VF).

The body can withstand more current at high frequency for the same effect. The frequency factor curve for VF in IEC 60479 is shown in Figure 4. By long-standing agreement among workers in the field; this curve can be extended to HF as has been done for the similar curves in IEC 60990.

The VF current shown in Figure 4 is about 8.5 times higher than the threshold for let-go at the same frequency. This means that slightly below this value one would be protected from VF but would not be able to let go of the circuit. No frequency compensating circuit has been developed in IEC 60990 for this curve since it is expected that products would not drive performance up against this limit.

Certainly one would not want to put a person into VF upon contact with any eBurn current. Curve C₁ of Figure 3 (the 5 percent VF curve, protecting 95 percent of the population) would be the absolute upper limit without any margin for safety.

The 1984 version of IEC 60479 had a footnote: “The point 500 mA/100 ms corresponds to a fibrillation probability in the order of 0.14%.” (This note appears to be the basis for choosing 500 mA as a limit.) This note has not been carried forward in the revision of the standard. The latest version of the standard provides Figure 5, which is a comparative curve of fibrillation data that provides a curve calculated from line voltage and frequency accidents showing 0.5 percent VF at 100 mA.

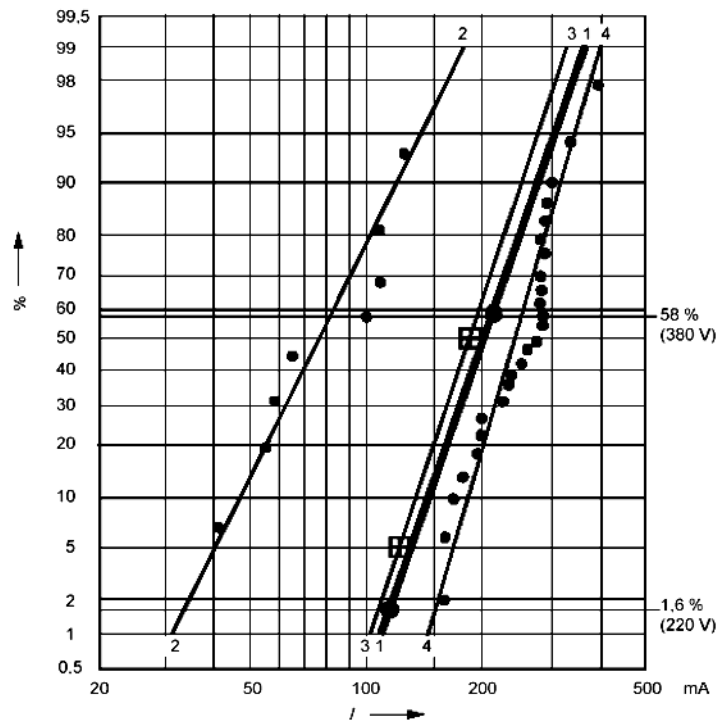

Figure 5. Comparative VF statistics, showing 0.5 percent VF at 100 mA (IEC 60479-1, Figure 19).

Key

- 1 fibrillation data for persons calculated from statistics of accidents ($U_T = 220\text{ V}$, 1.6%, $U_T = 380\text{ V}$, 58%)
- 2 fibrillation data for dogs, duration of current flow 5 s
- 3 fibrillation data for pigs, duration of current flow $t > 1,5 \cdot \text{heart-period}$
- 4 fibrillation data for sheep, duration of current flow 3 s
- ⊙ calculated values based on statistics of accidents ($U_T = 220\text{ V}$, 1.6%, $U_T = 380\text{ V}$, 58%, $I_T = 110\text{ mA}$ and 220 mA respectively) (1)
- ⊕ statistical values of measurements with pigs ($I(5\%) = 120\text{ mA}$, $I(50\%) = 180\text{ mA}$)
- (1) values corrected with the heart-current factor $F = 0,4$

The purpose of an eBurn specification is to limit the burn to a person touching such a circuit; but burns are not the only effect that needs to be considered. Coming in contact with such a circuit could lead to inability to let go at levels well below those that would set off VF. Inability to let-go is defined by the b-curve body current levels of IEC 60479 “conventional time/current zones of effects of ac currents.”

From this point forward we will examine these traditional eBurn current values along with determining the frequency at which they fall below the let-go curve, curve b. Using this frequency as a lower limit assures that any contact with the circuit will not result in inability to let go (including its effect at high frequency; see Figure 6 example).

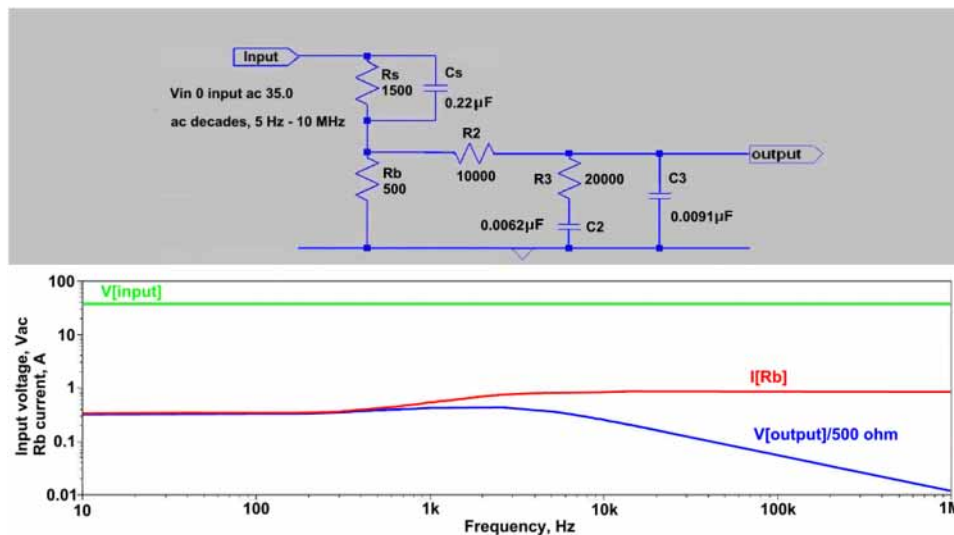

Figure 6. eBurn current from let-go circuit.

Standard	LF current	HF current	5 mA let-go frequency
IEC 60065	12.5 mA rms	50 mA rms	> 22 kHz
IEC60950	17.5 mA rms	70 mA rms	> 25 kHz
IEC 61010	17.5 mA rms (normal limit)	70 mA rms	>25 kHz
IEC 61010	126 mA rms (fault limit)	500 mA rms	> 180 kHz
prIEC 62368	12.5 mA rms	50 mA rms	> 22 kHz
prIEC 62368	25 mA rms	100 mA rms	> 36 kHz

Table 4. eBurn data summary plus let-go frequency limit.

In Table 4 a summary of the results of SPICE calculations adding the let-go lower limit frequency is shown. These limits should always be specified above the frequency shown.

The plot shown in Figure 7 summarizes the eBurn 5 mA let-go lower frequency point calculated for Table 4. Skin effects (reddening, current marks and carbonization, as shown in Figure 2) lines are shown for a small contact area. Operating below (and to the right of) the HF eBurn let-go curve always insures being below curve b of Figure 3 to ensure let-go from allowable eBurn currents. Operating above (and to the left of) the curve is forbidden under these conditions. Each of these effects must be taken into account in setting a limit.

Summarizing eBurn

- The eBurn limit only applies to sinusoidal signals.
- The area of contact is limited to small, finger tip contact to HF circuits.
- The time of contact is specified as being limited to reaction (< 1 sec).
- The allowable limit is specified for each type of person covered in the standard (ordinary normal user, supervised user, or trained serviceman). Why would we subject ordinary users to an eBurn?
- The allowable limit ensures that the hazard never exceeds the let-go limit vs. frequency curve above.
- These requirements should apply to accessible circuits which can be contacted at both poles. This includes all grounded secondary circuits and any isolated circuits where both contacts are easily available to touch.

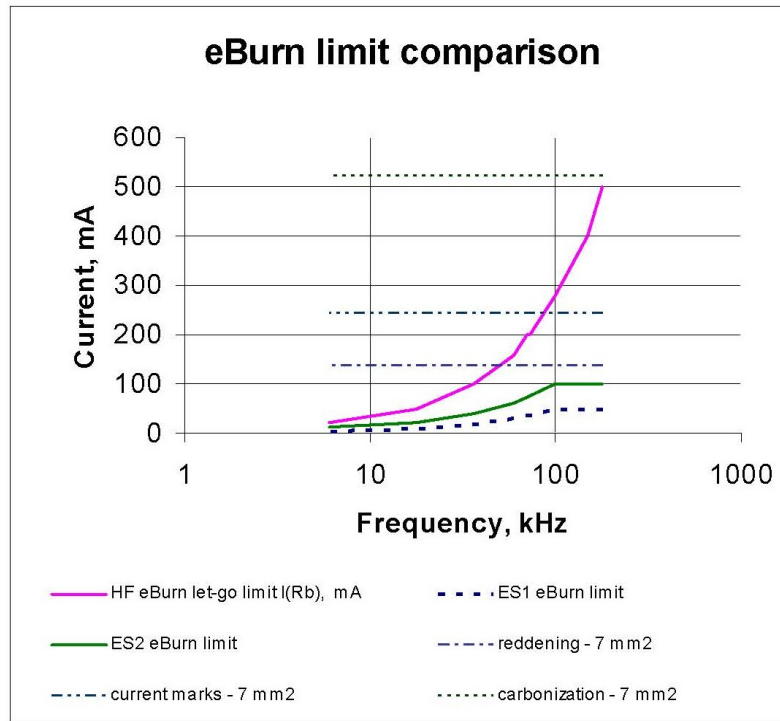

Figure 7. eBurn current comparison.

Peter E. Perkins, PE is an independent product safety and regulatory consultant. He is a member of IEC TC64 (IEC 60479, IEC 61201); IEC TC 108 (IEC 60950); convenor of IEC TC 108/WG5 (IEC 60990); US/TAG-TC109 (IEC 60664); US/TAG-TC64 (IEC 60479, IEC 61201); US/TAG-TC66 (IEC 61010); and US/TAG-TC108 (IEC 60950). He can be reached at p.perkins@ieee.org or 503-452-1201.

Part 2: Electric Shock will appear in the next issue of PSEN.

The International Symbol of
Engineering Excellence



**Boost
Your
Career...**

**With
Certified
Excellence!**

**A Personal Credential For The
21st Century Professional**

iNARTE, Inc.
840 Queen Street + New Bern + NC 28560
1-800-89-NARTE
Visit us at www.narte.org

Tip: Best way to get your boss to approve your trip to the 2008 Symposium on Compliance Engineering is to submit a paper that gets accepted for the symposium! Or volunteer and tell him you have to be there!

Advantages of Membership in the IEEE PSES

Makes you part of a community where you will:

- Network with technical experts at local events and industry conferences.
- Receive discounts on Society conferences and symposiums registration fees.
- Participate in education and career development.
- Address product safety engineering as an applied science.
- Have access to a virtual community forum for safety engineers and technical professionals.
- Promotion and coordination of Product Safety Engineering activities with multiple IEEE Societies.
- Provide outreach to interested engineers, students and professionals.
- Have access to Society Publications.



E-Mail List: <http://www.ieee-pses.org/emc-pstc.html>
Virtual Community: <http://www.ieee-communities.org/emc-pstc>
Symposium: <http://www.ieee-pses.org/symposium/>

Membership: The society ID for renewal or application is "043-0431". Yearly society fee is US \$35.

Seeking Nominations for IEEE Medals and Recognitions

The IEEE Awards Board is seeking nominations for IEEE Medals and Recognitions and encourages the use of its online Potential Nominee Form. This form allows a preliminary review of a nominee by the selection committee and an opportunity to obtain feedback prior to submitting an official nomination form. The Potential Nominee Form is available on the IEEE Awards Web Page at:

<http://www.ieee.org/portal/pages/about/awards/noms/potnomform.html>

The deadline for submission of an official nomination form for any of the IEEE Medals and Recognitions is 1 July 2008. For questions concerning the Potential Nominee Form, please contact awards@ieee.org.



IEEE PSES Membership savings
UL University Offers
IEEE PSES Members
15 Percent Discount

UL University (ULU) has established a discount code which will provide all IEEE-PSES members with a 15 percent discount off the price of all ULU instructor-led workshops, online programs, videos, books, and other services/products offered under the ULU brand. The discount is automatically applied during registration or purchase of ULU products. Registration or product purchase can be accomplished online at www.uluniversity.com or by calling 888-503-5536 in the U.S. or the country-specific number posted on the ULU website.

To receive the discount, members must enter or mention the discount code found in the Members Only section of the PSES website.

If you or any member has specific questions regarding ULU products or services, please call or email me or call the local country specific number posted on the UL University website.

Tony Robertson
Manager – Customer Training

News and Notes

Society

IEEE Gold program. The IEEE has put in a requirement that we have one GOLD member on our IEEE PSES Board of Directors. What is a Gold member you ask? It is a graduate of the last decade. So if you have graduated in the last 10 years and do not mind volunteering, please send your info to Jim Bacher at j.bacher@ieee.org. We will select one of those who apply for the opening to hold the position on the PSES BoD.

IEEE PSES Board of Directors. We held our second annual BoD meeting in Denver on June 20. The next meeting BoD meeting will be the Sunday before the Symposium in Austin Texas. It will be held at the Symposium Hotel. The meeting is open to the public. All are welcome to attend. We just ask to let us know you are coming so we can make sure we have enough chairs for everyone. Just send a note to either Daniece Carpenter or Jim Bacher to let us know.

IEEE PSES Web site for Jobs. Do not forget we have a web site where we have placed current regulatory job openings.

Notes

UW to offer Product Liability Conference

The College of Engineering, Department of Engineering Professional Development of the University of Wisconsin-Madison will offer its twentieth annual Product Liability Conference September 9–11, 2008 at the Madison campus.

The conference will feature presentations by an insurance company forensic specialist, a plaintiff attorney, several other attorneys, a UW professor, a corporate director of product integrity, a warning label specialist, a safety information specialist, a toxicologist, and the chief justice of the Wisconsin Supreme Court. Two of the three days will include periods set aside for open interaction with the presenters.

For more information, visit
<http://epd.engr.wisc.edu/webJ725>
or call 800-462-0876.

NEMA to offer product safety liability conference

The U.S.-based National Electrical Manufacturers Association will present a Product Safety Liability Conference September 29–October 1, 2008 at the Peabody Hotel, Memphis, TN. Topics to be covered include product recalls; risks of sourcing goods from third parties; expected Consumer Product Safety Commission legislation; and best practices to address legal risks and product reputation and brand name. For more information, visit www.nema.org/events/prodsafetyconference.cfm.

What's new

OSHA will reopen comment period for SDOC

Under pressure resulting from a spring meeting of the European Union Transatlantic Economic Council, where the focus was on “unnecessary barriers to trade,” the U.S. Occupational Safety and Health Administration (OSHA) will again open a *Federal Register* public comment period on the matter of Supplier Declarations of Conformity (SDOC).

The Information Technology Industry Council has proposed to OSHA that manufacturers of some electrical and electronic equipment be permitted to self-declare compliance with product safety standards instead of the third-party certification by a Nationally Recognized Testing Laboratory presently required by OSHA. After the comment period for the original proposal a couple of years ago, OSHA had decided not to change the present system. It is unclear whether the new comment period is likely to result in any changes, or whether it is primarily a U.S. gesture to mollify the Europeans.

Safety Link web site revamped

The Safety Link, a comprehensive collection of electrical product safety and standards resources online since 1995, has been revamped. The Safety Link provides ready access to the World's electrical product safety test labs including BSI, CSA International, FM Approvals, Intertek, the NRTLs, the TUVs, UL, VDE and hundreds more; standards bodies such as ANSI, CENELEC, IEC, EIA, and ETSI; government links such as BERR, CPSC, FCC, OSHA, NIST and the EU.

CE marking resources can be found, along with links to many EU Directives and associated information related to electrical product safety compliance such as those in the fields of EMC/RFI, Telecommunications, Quality, EHS, WEEE/RoHS and the Environment. The Safety Link is at: www.safetylink.com. To gain full benefit of the redesign and the new search and translation options available, click the “Optimize” tab.

RoHS may be expanded

Although nothing official has been announced as of this writing, indications are that at least eight substances will be added to the list of restricted materials under Directive 2002/95/EC (RoHS Directive). The Directive presently sets limits in covered products for lead, mercury, cadmium, hexavalent chromium, and two brominated flame retardants.

It is said that the consultancy which provides regulatory analysis for the European Commission will soon recommend that the following be added to the RoHS list: flame retardants TBBPA and HBCDD; phthalates DEHP, BBP, and DBP; medium-chained and short-chained chlorinated paraffins (used as flame retardants and plasticizers); and nonylphenolethoxylates (used as surfactants). Opponents of this move say that it is unnecessary because of the REACH regulations coming into effect.

EDITORIAL

The Product Safety Engineering Society continues to grow, but adding members remains an important concern. Although the present time frame is the most critical period (a la corporate quarterly results), consideration of long-term scenarios is probably also important.

Earlier editorials suggested that perhaps the PSES ought to consider putting together some sort of Product Safety Engineering course materials or modules that could be offered to engineering schools. The modules would deal with product safety/HBSE, standards and regulatory compliance, and standards development. An obvious progression would be to develop a one-hour presentation, and gradually build on that to reach a one-week or even a one-semester module.

It is conceivable that logistical support for such an effort could come from outside the PSES. An article in *The Wall Street Journal* reported on March 6, 2008 that "...corporations are reaching out to classrooms—drafting curricula"... "Hoping to create a pipeline of workers far into the future, these corporations furnish free lesson plans and may also underwrite classroom materials, computers or training seminars for teachers"... "Companies that employ engineers, fearful of a coming labor shortage, are at the movement's forefront." Among the companies mentioned are Lockheed Martin, Rolls-Royce engines, Intel, Cisco Systems, and the National Fluid Power Association.

The focus of the article was on efforts to interest high school students in engineering careers, but it is easy to envision something parallel to that to interest college students who have already chosen engineering in careers related to product safety.

Furthermore, the article says that "[High] Schools, for their part, have embraced corporate support as state education funding has remained flat for a decade... Teachers, meanwhile, often welcome the lesson plans, classroom equipment and the corporate-sponsored professional development sessions." Surely colleges are in the same boat.

There may even be a ready-made mechanism for PSES to both secure backing and get involved. According to the article, many corporations support interest in engineering careers through a non-profit organization called Project Lead the Way (www.pltw.org), which develops engineering coursework that is offered to schools nationwide in the U.S. Should PSES approach PLTW to explore whether that organization might want to support work by PSES to develop product safety course modules?

It would take a special kind of PSES member to get involved in something like this. Why? Because it requires an altruistic understanding that the invaluable payoff will only begin years down the road, perhaps after he or she is gone from the scene. Do we have such people?

Electric Strength Test: What Voltage Should be Used?

by Lal Bahra

The three types of electrical spacings are clearance, creepage distance, and thickness of solid insulation. Figure 1 illustrates these three quantities.

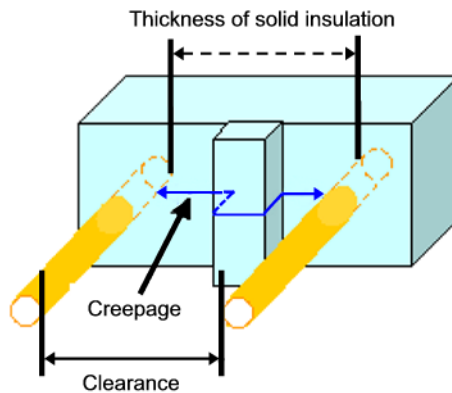

Figure 1: Clearance, creepage distance, and thickness of solid insulation.

The electric strength voltage test is conducted to measure the adequacy of a given clearance (spacing through air) or a given thickness of solid insulation.

Clearance

For air, the electric strength is provided by the data in table A.1 of IEC 60664-1¹. Figure 2 provides a plot of the table data.

The electric strength test voltage for a clearance is based on the maximum peak voltage that appears across the clearance. (This voltage is the maximum of the transient overvoltage from external disturbances, peak voltages generated in the equipment, and temporary overvoltages that the equipment sees due to earth faults in electrical power systems.)

Creepage distance

A creepage distance is affected by the rms working voltage or dc voltage that appears across it and is not affected by short-term peak or transient overvoltages including transients. Accordingly, various standards prescribe creepage distance tables and in general, those standards do not prescribe any electric strength test voltage to verify creepage distances.

However, by physical limitation, the required creepage distance cannot be smaller than the required clearance. Therefore, if the calculated creepage distance is smaller than the applicable clearance, the required clearance becomes the required creepage distance.

Continued on Page 20

**Air Insulation
(withstand voltages)**
Data from IEC 60664-1(edi), Annex A, Table A1

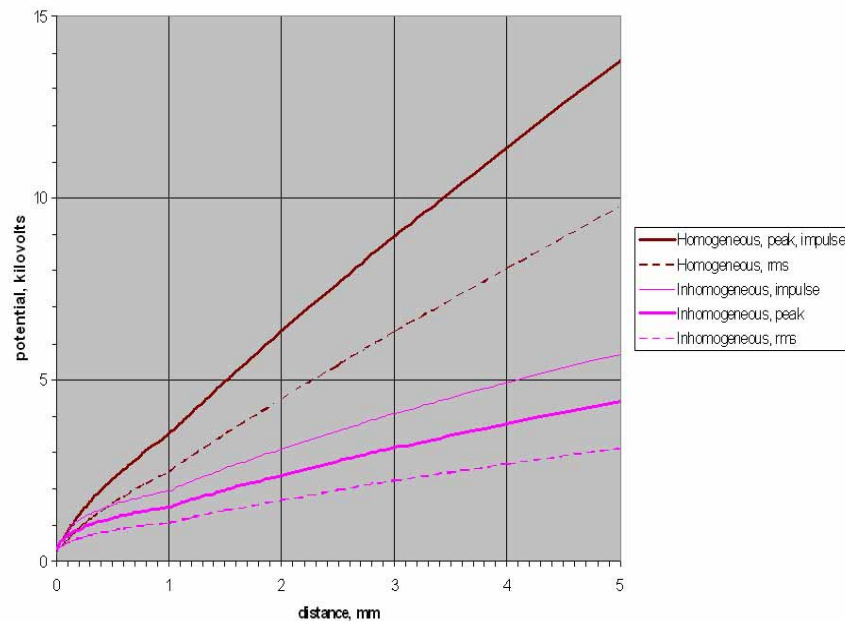

Figure 2: Air insulation withstand voltages. (Note - Test voltages in all cases are calculated for basic insulation.)

Solid insulation

For solid insulating materials, the electric field strength is provided in the manufacturer’s data sheet for the material usually in kV per unit thickness (for example Kapton (a form of polyimide) has an electric strength of 303 kV/mm).

The required electric strength test voltage for solid insulating materials is based on the peak voltage that appears across these materials as used in the equipment. The value of the electric strength test voltage depends upon many parameters, such as:

- Transient overvoltages from the electrical power system (depending upon the location of the equipment within the building power distribution² and transient overvoltages present on external circuits entering the equipment);
- Short-term and long-term temporary overvoltages (due to faults in the power distribution system³);
- Repetitive peak voltages generated in the equipment; and
- Steady-state voltages in the equipment.

Historical test voltage values

Various product safety standards provide tables prescribing specific electric strength test voltages, but the tables may not take all these parameters into consideration. I remember when I started into product safety, many of the standards had an electric strength test voltage of 900 V rms, which was raised to 1000 V rms and then to 1000 plus twice the rated rms voltage. These values have often been increased when a new edition or amendment is published. However, these increases did not overtly take into account the overvoltage transients that are present on the electrical power system.

Present test voltage values

The electrical power system has transient overvoltages². The values of the transient overvoltages were standardized by TC64, the IEC technical committee responsible for developing requirements for building wiring, installation and other associated concerns.

A transient overvoltage, when it reaches the equipment, can be common mode (line-to-earth) or differential mode (line-to-line). We are more concerned with the common mode transient overvoltage as this is much higher than the differential mode overvoltage and it stresses basic insulation from the mains to ground and also from mains to secondary circuits (these circuits are either referenced to ground or they get earthed in the application). The differential mode overvoltage is usually much smaller and stresses the functional insulation.

A major change in determining test voltages has been introduced^{4, 5}, based on an actual study of transient overvoltages entering equipment via the electrical power system and other such sources and requiring an electric strength test voltage that covers the transient overvoltage. This article focuses on the value of the electric strength test voltage required for clearances and for solid insulation.

The new clearance requirements⁶ are designed to ensure that clearances can withstand the transient overvoltage from electrical power systems. The tables for clearances in various standards usually have a small margin, i.e. they are slightly higher than the new clearances, and if the clearances are designed to the dimensions in those standards, there is no need to conduct an electric strength test as the dimensions can withstand a slightly higher electric strength test voltage because of the margin in those standards. The electric strength is conducted to evaluate the solid insulation, because clearances in the tables can withstand a higher electric strength test voltage than historically prescribed ($2U + 1000 \text{ V}$ is really for solid insulation).

Solid insulation is just another medium instead of air and is affected by the transient overvoltage from the electrical power system or from other external circuits such as TNV circuits entering the equipment. In addition, the solid insulation is also affected by short-term and long-term temporary overvoltages. Solid insulation must also withstand stresses due to the voltages generated in the equipment (such as high voltage in copier and laser printer power supplies and high voltages generated by a flyback transformer).

The objective of the electric strength voltage test is to make sure the insulation will withstand transient overvoltages and any short-term temporary overvoltage, and thus contribute to the safety of the equipment.

From the above, it is apparent that if clearances are designed to the specified dimensions, then the objective of the electric strength voltage test is to test the solid insulation. The test shall be conducted in such a way that it stresses the solid insulation required to be tested. The electric strength voltage test shall not stress those solid insulations or clearances which are not affected by the transients or receive an attenuated transient. Components connected across such solid insulations can be disconnected before the test (such as capacitor from line to ground when primary to secondary is tested for reinforced insulation and ground is tied to the secondary circuit).

If solid insulation alone needs to be tested then the clearance should be of such a value that is not damaged by the test voltage for the solid insulation (see Figure 6 in IEC 60065⁷ for an example of equipment that can be used for this purpose). Figure 1 shows a typical usage in an actual equipment and shows all three i.e., clearance, creepage distance and thickness of solid insulation. For solid insulation testing purposes, you would require electrodes that touch the insulation uniformly, and

Continued on Page 24

Compliance Engineering**Sponsored by the IEEE Product Safety Engineering Society****20-22 October 2008 Austin, Texas****Austin Marriott North****Call for Papers, Workshops, and Tutorials**

The IEEE Product Safety Engineering Society seeks original, unpublished papers and tutorials on all aspects of product safety and compliance engineering including, but are not limited to:

- **Product Safety:** Consumer, medical, computer (IT), test and measurement, power supplies, telecommunication, industrial control, electric tools, home appliances, cellular and wireless, etc.
- **Product Safety 101:** Papers / presentations intended for new safety engineers. This will include certification processes, product evaluation and testing, report writing, and working with designers to get it right the first time.
- **Safety Subjects:** Electrical, mechanical, fire, thermal, chemical, optical, software, functional, reliability, etc.
- **EMC / RF:** Electromagnetic emissions, electromagnetic immunity, regulatory, Introduction to EMC/RF for the safety engineer and compliance engineer.
- **Components:** Grounding, insulation, opto-couplers, capacitors, transformers, current-limiters, fuses, power line filters, ferrite, environmental, electromagnetic emissions, electromagnetic immunity, regulatory, etc.
- **Certification:** Product safety, electromagnetic emissions, electromagnetic immunity, environmental, processes, safety testing, regulatory, etc.
- **Standards Activities:** Development, interpretations, status, interpretations, country requirements, Laboratory Accreditation, etc.
- **Safety Research:** Body physiological responses to various hazardous energy sources, unique safeguard schemes, etc.
- **Environmental:** RoHS, WEEE, EuP (Energy-using Products), Energy Star, Packaging Directives, REACH (Chemical), CeC, etc.

**Mark your calendars to attend the
2008 IEEE Symposium on Product Compliance Engineering.**

Author's Schedule

Intent to present and topic (e-mail) April 29, 2008

Draft e-paper June 1, 2008

Notification of Acceptance July 6, 2008

Complete e-paper August 17, 2008

See <http://www.ieee-pses.org/symposium/index.html#CFP> for more details on requirements and dates.

www.ieee-pses.org/symposium

ChairGary Schrempp
Gary_Schrempp@Dell.com**Co-Chair**Doug Nix
dnix@ieee.org**Treasurer**

TBD

SecretaryBrian Greaney
brian.a.greaney@hp.com**Technical Program**Bob Griffin
bobgriff@us.ibm.com

And

Gary Tornquist
garytor@microsoft.com**Product Safety 101
Technical Program**

Rich Nute, richn@ieee.org

Exhibits/PromotionsThomas Ha
tom@gmcompliance.com**Exhibitor Manager**Sue Kingston
s.kingston@ieee.org**Registration**Diana Krynski
d.krynski@ieee.org**Arrangements/Logistics**

TBD

**Communications,
Webmaster and Program
Records**Dan Roman
Dan.Roman@ieee.org**At-Large Members**Jim Bacher
Jack Burns
Daniece Carpenter
Elya Joffe
Henry Benitez
Ken Thomas

2004 / 2005 / 2006 / 2007 IEEE-PSE Symposium

CD Purchasing Information

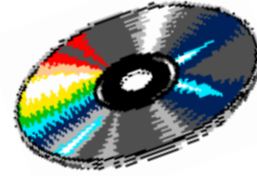

SYMPOSIUM PAPERS ON CD:

The Product Safety Engineering Society continues to offer the 2004 IEEE PSES records for sale. The cost for the CD is \$35 plus shipping and handling for IEEE members; \$50 plus shipping and handling for non-IEEE members. At this time, check or money orders are the means for payment. Please provide the following information:

CDs to be shipped to- (Please print or type.)

Name: _____

Mailing address: _____

IEEE member number: _____

Shipping and handling: \$5 per CD

Payment: Check or money order.

Make Check or money order to: "IEEE Product Safety Society"

Quantity 2004: _____ x \$35 = _____ for IEEE members

Quantity 2004: _____ x \$50 = _____ for non-IEEE members

Quantity 2005: _____ x \$35 = _____ for IEEE members

Quantity 2005: _____ x \$50 = _____ for non-IEEE members

Quantity 2006: _____ x \$35 = _____ for IEEE members

Quantity 2006: _____ x \$50 = _____ for non-IEEE members

Quantity 2007: _____ x \$35 = _____ for IEEE members

Quantity 2007: _____ x \$50 = _____ for non-IEEE members

S&H: QTY _____ x \$5 = _____

Total = _____

Send payment to:

IEEE Product Safety Engineering Society
c/o Richard Georgerian, PSES Board of Directors
7103 Sioux Court
Longmont, CO 80504
U.S.A.

Depending on stock availability allow 2 to 3 weeks for delivery.

large clearances to avoid any flashover. Such a test rig is good for determining adequacy of solid insulation on an experimental basis. To test the solid insulation in actual equipment, the clearance must be slightly larger (than specified in the tables in the standard) and any component that is not required to be tested for that electric strength test voltage must be disconnected (in order to avoid disassembly of the equipment).

Two approaches are available

Two approaches can be taken to conduct electric strength voltage tests.

The first approach is to test the solid insulation twice, once with an impulse electric strength voltage test and again with a continuous ac electric strength voltage test. The impulse electric strength test voltage is based on the transient overvoltages and the continuous ac electric strength test voltage is based on the short term temporary overvoltage and the voltages generated in the equipment.

The second approach is to conduct only a single ac electric strength voltage test that covers both the impulse and the short-term temporary overvoltage.

The new tables^{4, 5} were developed using a logical approach to base the electric strength test voltage on the maximum value of the transient overvoltage. The peak of the transient overvoltage can be converted to a peak ac electric strength test voltage. The draft IEC TR 60664-2-1⁸ specifies a different approach than the above and different from table F.5 of IEC 60664-1⁹. It requires an impulse electric strength voltage test based on the transient overvoltage; an ac electric strength voltage test (to cover transient overvoltage) whose peak voltage is equal to the impulse test voltage; and an ac electric strength voltage test to cover short-term temporary overvoltage, long-term temporary overvoltage and recurring peak voltages (in the equipment). This article considers all the parameters that affect the electric strength test voltage.

We have to consider electric strength test voltages based on the following six situations.

1) Electric strength test voltage based on transient overvoltage (peak impulse)

Solid insulation must be able to withstand the transient overvoltage coming from the electrical power system or other external circuits. For example, for a 230 V electrical power system, the transient overvoltage in the building is 2500 V peak. Solid insulation and clearances associated with the solid insulation both must be able to withstand this transient overvoltage.

If we are conducting a regular ac electric strength voltage test or dc electric strength voltage test, Figure 2 provides values of impulse voltage, ac peak voltage, and ac rms voltage that a clearance distance will withstand. For 2500 V peak transient overvoltage (impulse¹), solid insulation has to withstand a sinusoidal waveform electric strength voltage test of 1923 V peak ac or dc or 1360 V rms. The impulse withstand peak voltage is higher than the ac peak withstand voltage because the rise time of the impulse is very fast and electrons take time to travel from one conductive part to the other and by that time the voltage starts to fall down.

From Figure 2, it is apparent that the withstand voltage is directly proportional to the clearance distance. As the distance increases, the withstand voltage also goes up. Figure 2 shows the relationship of the withstand voltage (impulse, peak ac or dc and rms) to clearance distance.

2) Electric strength test voltage based on short-term temporary overvoltage

Solid insulation must withstand a short-term (less than 5 s) temporary overvoltage. Short-term temporary overvoltage occurs due to earth faults in the electrical power system substation or load. When an earth fault occurs on a 230 V IT or TT electrical power system, the disconnection of power may occur in less than 5 s, and the temporary overvoltage may be as high as 1430 V rms¹⁰. For temporary

overvoltages on IT and TT electrical power system, the voltage (U_2)¹⁰ at the low voltage load side is greater than the line to Neutral voltage (U_0).

The magnitude of the voltage at the equipment is dependent on the value of the earth fault current (I_F), at the substation. Also, for IT and TT electrical power systems, for temporary overvoltages, the voltage at the substation (U_1) at the low voltage supply side is greater than the line to Neutral voltage (U_0). U_1 is only slightly greater than U_2 (the difference is line voltage drop). We can't predict (calculate) the earth fault current (I_F) because it occurs at the substation. The IEC standard¹⁰ requires utilities to limit the values of the short-term temporary overvoltage to no more than $1200 + U_0$ (or U_N)¹⁰. Therefore, for TT and IT electrical power systems, the basic insulation is subjected to a stress of $U_0 + 1200$ V rms for up to 5 s. This temporary overvoltage may be present on the 230 V power systems for up to 5 s. For equipment supplied by 230 V power systems, this will work out to be $1200 + 230 = 1430$ V rms¹⁰.

3) Electric strength test voltage based on long-term temporary overvoltage

When an earth fault occurs and the disconnection of power takes longer than 5 s, the long-term temporary voltage is relatively low. The IEC standard¹⁰ requires utilities to limit this long-term temporary overvoltage to 250 plus the line-to-earth (or neutral) voltage.⁹ Solid insulation must withstand the long-term temporary overvoltage test. For equipment supplied by 230 V power systems, the long-term temporary overvoltage works out to be $250 + 230 = 480$ V rms. A TN system is not subject to long-term temporary overvoltage due to an earth fault.

4) Electric strength test voltage based on steady state peak working voltage

Solid insulation must withstand stresses due to steady state peak working voltages generated in the equipment (steady state ac or dc voltages). The electric strength test voltage is equal to the peak working voltage plus a margin that is decided by the technical committee responsible for the end product.

5) Electric strength test voltage based on repetitive peak working voltage

Solid insulation must withstand stresses due to repetitive peak working voltages generated in the equipment (such as the peak working voltages generated in a switch mode power supply). This shall be equal to 1.5554 times the repetitive peak working voltage¹¹. For equipment supplied by a 230 V power system, if the repetitive peak working voltage is 600 V, the electric strength test voltage will be $600 \times 1.5554 = 933$ V. In this example, the electric strength test voltage is less than the short-term voltage electric strength test voltage.

6) Partial discharge test

IEC 60664-1, 2nd Ed., anticipates that a partial discharge test needs to be conducted. While this requirement must be observed, this article's focus is to determine the test voltage for electric strength test. Therefore, partial discharge is not discussed here.

Selecting the electric strength test voltage

In this article, the only electrical power system voltage considered is 230 V for Overvoltage Category II¹². When determining electric strength test voltages, all system voltages and all overvoltage categories need to be taken into account.

From the above discussion, the highest electric strength test voltage for equipment supplied from a 230 V electrical power system is 1430 V ac rms due to short-term temporary overvoltage. For equipment supplied from a TN electrical power system, the highest electric strength test voltage is determined by items 1, 4 and 5 above. The short-term and long-term temporary overvoltages are not taken into account.

IEC 60664-1, 2nd Ed., also makes the following statement: "If the peak value of the a.c. test voltage is

equal to or higher than the rated impulse voltage, the impulse voltage test is covered by the a.c. voltage test.”

The peak impulse voltage (rated impulse voltage) for a 230 V system is 2500 V peak. Therefore, the 1430 V rms (2022 V peak) short-term temporary overvoltage test voltage does not cover the peak impulse electric strength voltage test of 2500 V peak. For equipment supplied by a 230 V power system, the peak impulse electric strength voltage test needs to be conducted separately or the electric strength test voltage needs to be 2500 V peak ac or 1768 V rms if a single test is conducted.

The impulse test voltage for equipment supplied from a 230 V electrical power system is 2920 V⁸ (and not 2500 V peak) for verification of clearances if the test is conducted at sea level even though the expected transient is only 2500 V. Therefore, the test voltage for clearance shall be either 2920 V peak or $2920/1.414 = 2065$ V ac rms. For the solid insulation, we can either do two tests or a single test. If the option is two tests, then the first test is conducted at 2920 V peak impulse and the second test is conducted at 1768 V rms (or 2500 V peak ac). If the option is a single test then the test voltage is 2065 V ac rms (or 2920 V peak ac).

So far we have calculated the values shown in the table for the electric strength test voltage for equipment supplied from a 230 V power system.

Conclusion

Compliance to the electric strength requirement of a clearance is determined by a physical measurement of that clearance or the application of an electric strength test voltage to that clearance.

Compliance with the creepage distance requirements is determined by a physical measurement of that creepage distance. There is no electric strength voltage test to verify creepage distances.

Compliance to the electric strength requirement of solid insulation is determined by the application of an electric strength test voltage to that solid insulation.

When determining the value of the electric strength, all parameters that stress the solid insulation must be taken into account. The stress voltages generated through different mechanisms can be of different magnitudes. The worst-case test voltage needs to be taken into account. In addition, we need to follow the requirements for electric strength in basic safety publications.

Even though the approach taken in designing tables for electric strength in the future HBSE standard IEC 62368 is correct, the statement in IEC 60664-1, 2nd Ed., “If the peak value of the a.c. test voltage is equal to or higher than the rated impulse voltage, the impulse voltage test is covered by the a.c. voltage test” needs to be taken into account.

**Calculated Test Voltages
(Supply = 230 V, Overvoltage Category = II)**

Method of calculation	Two tests				Single test
	Test voltage for basic insulation when both impulse withstand and peak ac or dc tests are conducted				Test voltage for basic insulation (clearance and solid insulation) peak ac
	Impulse		Peak ac		
Across the clearance	Across the Solid insulation	Across the clearance	Across the Solid insulation		
Using Table A.1 of IEC 60664-1	2500	2500	1923	1923	1923
Using short term temporary overvoltage (<5 s)	—	—	2022	2022	2022
Using Long term temporary overvoltage (>5 s)	—	—	1032	1032	1032
Testing at no more than the transient overvoltage peak voltage	2500	2500	2500	2500	2500
Testing at sea level (in accordance with table F.5 of IEC 60664-1)	2920	2920	2920	2500	2920

References

- ¹ Table A.1, Annex A, IEC 60664-1, Ed. 2: 2007, *Insulation coordination for equipment within low-voltage systems – Part 1: Principles, requirements and tests*
- ² Table F.1 of IEC 60664-1, 2nd Ed: 2007 *Insulation coordination for equipment within low-voltage systems - Part 1: Principles, requirements and tests*
- ³ Clause 442 of IEC 60364-4-44, 2nd Ed: *Low-voltage electrical installations – Part 4-44: Protection for safety – Protection against voltage disturbances and electromagnetic disturbances*
- ⁴ Table 5C of IEC 60950-1 2nd Ed: *Information technology equipment – Safety – Part 1: General requirements*
- ⁵ Table 5.20 of 108/276/CDV: IEC 62368 Ed 1.0: *Audio/Video, Information and Communication Technology Equipment – Safety - Requirements*
- ⁶ Table F.2 of IEC 60664-1, 2nd Ed: 2007 *Insulation coordination for equipment within low-voltage systems - Part 1: Principles, requirements and tests*
- ⁷ Figure 6 of IEC 60065: 2002, *Audio, video and similar electronic apparatus — Safety requirements*
- ⁸ Table 1 of 109/66/CD for IEC TR 60664-2-1: *Insulation coordination for equipment within low-voltage systems – Part 2-1: Application guide - Explanation of the application of the IEC 60664 series, dimensioning examples and dielectric testing*
- ⁹ Table F.5 of IEC 60664-1, 2nd Ed: 2007 *Insulation coordination for equipment within low-voltage systems - Part 1: Principles, requirements and tests*
- ¹⁰ Clause 442.2.2 of IEC 60364-4-44, 2nd Ed: *Low-voltage electrical installations – Part 4-44: Protection for safety – Protection against voltage disturbances and electromagnetic disturbances*
- ¹¹ Subclause 5.3.3.2.4 of IEC 60664-1, 2nd Ed: 2007 *Insulation coordination for equipment within low-voltage systems - Part 1: Principles, requirements and tests*
- ¹² Clause 443 of IEC 60364-4-44: 2nd Ed: *Low-voltage electrical installations – Part 4-44: Protection for safety – Protection against voltage disturbances and electromagnetic disturbances*

Lal Bahra is a P. Eng. in Global Regulations and Standards at Dell Inc.

The Product Safety Engineering Newsletter is published quarterly during the last month of each calendar quarter. The following deadlines are necessary in order to meet that schedule.

Closing dates for submitted articles:

1Q issue: February 1
2Q issue: May 1
3Q issue: August 1
4Q issue: November 1

Closing dates for news items:

1Q issue: February 15
2Q issue: May 15
3Q issue: August 15
4Q issue: November 15

Closing dates for advertising:

1Q issue: February 15
2Q issue: May 15
3Q issue: August 15
4Q issue: November 15

**Booked your trip to the 2008 Symposium on
Compliance Engineering yet?**

Institutional Listings

We invite applications for Institutional Listings from firms interested in the product safety field. An Institutional Listing recognizes contributions to support publication of the IEEE Product Safety Engineering Newsletter. To place ad with us, please see :

<http://www.ieee.org/ieeemedia>

Click here to go to the IEEE PSES advertising pdf

The Product Safety Engineering Society will accept advertisements for employment and place looking for work ads on our web page. Please contact Dan Roman for details at dan.roman@ieee.org .

The
Product
Safety
Engineering
Newsletter

Gary Weidner
GW Technical Services Inc.
2175 Clarke Drive
Dubuque, IA 52001-4125

CHANGE SERVICE REQUESTED